



National Aeronautics and
Space Administration

Educational Product

Teachers &
Students

Grades
5-8

EG-2000-09-004-GRC

NASA's Student Glovebox:

An Inquiry-Based Technology Educator's Guide

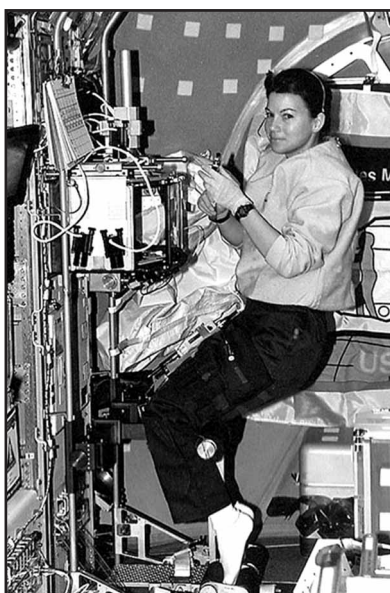

NASA's Student Glovebox Educator's Guide is available in electronic format through NASA Spacelink - one of NASA's electronic resources specifically developed for the educational community. This publication and other educational products may be accessed at the following address:

<http://spacelink.nasa.gov/products>

On the cover:

Top - A completed NASA Student Glovebox with demonstration materials inside.

Lower left - Mission Specialist Catherine Coleman works with the Space Shuttle Glovebox aboard the Space Shuttle Columbia on the second U.S. Microgravity Laboratory in 1995.

Lower right - Catherine Coleman demonstrates the NASA Student Glovebox on Earth.



NASA's Student Glovebox:

An Inquiry-Based Technology Educator's Guide

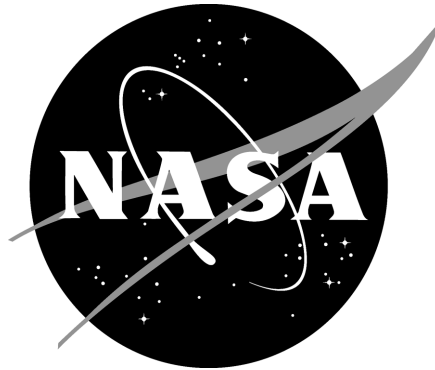

National Aeronautics and Space Administration

NASA Glenn Research Center
Cleveland, Ohio

NASA Marshall Space Flight Center
Huntsville, AL

NASA Headquarters
Washington, DC

This publication is in the public domain and is not protected by copyright. Permission is not required for duplication for classroom use. For all other purposes, give credit to NASA and the authors.



Acknowledgements

Writers:

Carla B. Rosenberg

Melissa J. B. Rogers

National Center for Microgravity Research on Fluids and Combustion
Cleveland, OH

Graphics and Layout:

Robin Estell

CST Inc.

Huntsville, AL

Activity Contributors:

Kathy Mullane Higgins

Hudson City Schools

East Woods School

Hudson, OH

Carla B. Rosenberg

National Center for Microgravity Research on Fluids and Combustion
Cleveland, OH



Table of Contents

National Technology and Science Standards.....	iv
Shuttle Glovebox.....	1
What Is a Glovebox?.....	1
Why Use a Glovebox?.....	1
Parts of a Glovebox.....	2
Build a NASA Student Glovebox.....	4
Droplet Investigation of Liquids.....	9
Activity.....	9
Answer Key.....	13
Worksheet.....	16
Websites.....	18
NASA Educator Resource Centers.....	19
Spacelink.....	22



National Technology and Science Standards

NASA's Student Glovebox is a middle-school Educational Product for use in self-contained classrooms or in technology and physical science classes. This material was developed to meet the specific technological design standards cited below.

Standards for Technological Literacy: Content for the Study of Technology [Grades 6-8]

by International Technology Education Association

Abilities for a Technological World

-Students will develop abilities to apply the design process.

National Science Education Standards [Grades 5-8]

by National Research Council

Abilities Necessary to Do Scientific Inquiry

-Design and conduct a scientific investigation.

-Use appropriate tools and techniques to gather, analyze, and interpret data.

-Develop descriptions, explanations, predictions, and models using evidence.

-Think critically and logically to make the relationships between evidence and explanations.

Science and Technology

-Abilities of technological design.

Payload Specialist Roger Crouch modifies experiment hardware that levitates fluid droplets, during the MSL-1 mission.



Shuttle Glovebox



This Glovebox flew on the Space Shuttle.

What Is a Glovebox?

A Glovebox is a sealed container with built-in gloves. Astronauts perform small experiments and test hardware inside of them. Gloveboxes have flown on the Space Shuttle and *Mir*. The *International Space Station* will have a permanent Glovebox on the U.S. Laboratory, *Destiny*.

Why Use a Glovebox?

There are good reasons for doing an experiment in a Glovebox on orbit. The sealed Glovebox keeps flames, particles, fumes, and spilt liquids away from crew members and out of the cabin air. Fumes or particles can irritate crew members' skin and eyes or make the crew sick. Spills could damage electrical

equipment. Any work with flames requires precautions, especially on a spacecraft. For some studies, it is important to protect experiment samples from the cabin air and crew. A closed environment may be essential to control experiment variables.

A Glovebox is a valuable research tool. It helps scientists find more effective methods for performing an experiment, like growing better crystals. Scientists can use the Glovebox to make sure small parts of a large experiment work. This helps build more reliable equipment. For example, they can see if a part, like a nozzle, will work on orbit, and see which nozzle shape works the best.

One reason NASA created the Glovebox was so researchers could fly simple investigations into space more quickly. Normally, science teams work with NASA about seven years before their experiment is ready to go into space. Seven years may seem long, but the process is complex and takes careful planning. Glovebox research has a shorter development time, usually taking three to five years.



Parts of a Glovebox

Exterior

Window - On the top of the Glovebox is a window so the user can see inside the chamber. The window is made of an acrylic that is scratch-resistant and fog-resistant. A microscope can be mounted on the top. Velcro™ rims the window so shades can be added.

Controls - Above the viewing area are controls for power, lighting, video, and other systems.

Exterior Front

Glove Holes - Two doors have holes where rubber gloves attach. Crew members can use heavy rubber gloves, light surgical gloves, or their bare hands. Heavy gloves protect the researchers better, but are harder to use. Surgical gloves are thinner and better for more precise finger control. Believe it or not, crew members sometimes wear surgical gloves over rubber gloves to improve the fit.

Doors - On the outside of the Glovebox are three removable doors. Equipment and supplies are put into the Glovebox using one of the three front doors.

Video Cameras - Cameras can be mounted on three of the doors so the astronaut and the scientists on Earth can record what happens inside the chamber.

Exterior Sides

Strips of Velcro™ - Along the outside walls, strips of Velcro™ keep supplies and notes from floating out of reach. The doors are rimmed with Velcro™ so they can be taken off and stored out of the way.

Door - On the left side of the glovebox is a fourth door, used to insert or position equipment inside the Glovebox.

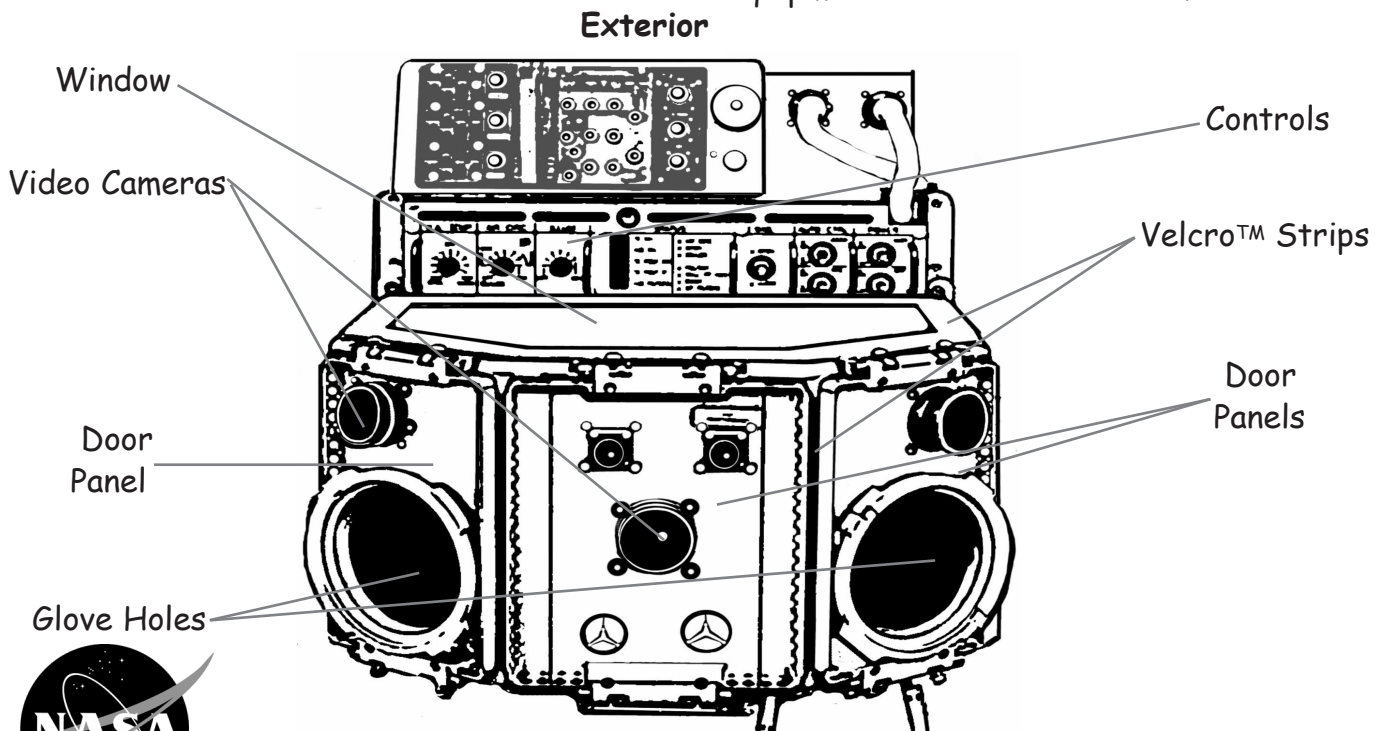

Interior

The Glovebox has a 44 liter capacity (about the volume of a ten gallon aquarium). When powered up, the Glovebox interior has a negative pressure which causes the gloves to inflate with air. The bottom is made of steel. Equipment parts often have magnetic strips on the bottom so they stick to the floor and stay in place. The inner chamber also has clamps and Velcro™ strips to keep equipment, tools, and samples from floating around.

Connectors - There are various connectors for power, fans, and other utilities needed to run experiments.

Air Filter Vents - The air inside the Glovebox circulates through four round vents to filter out particles such as soot.

Air Filter - Air flow enters the Glovebox through a bank of air filter holes on the right interior wall.

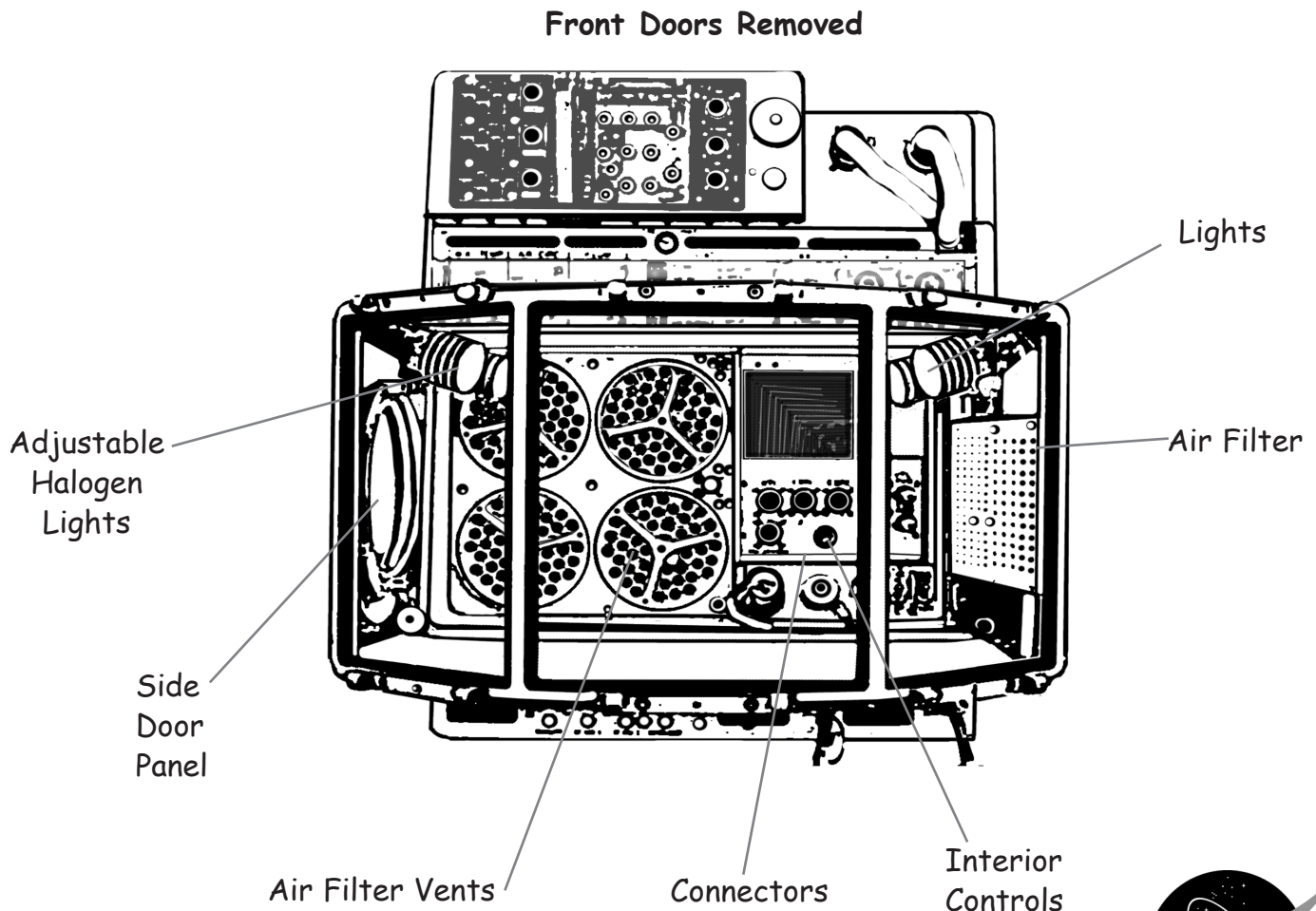

Build a NASA Student Glovebox

The artwork in this package contains photographs of the interior and exterior of a Glovebox that flew on several Space Shuttle missions. The pictures have been sized to fit the dimensions of an empty copier paper box, so you can create a Glovebox for use in the classroom. The instructions below describe how to build the Glovebox with a window lid and glove inserts. **NOTE:** IT MAY NOT BE APPROPRIATE FOR STUDENTS TO BUILD THIS GLOVEBOX. BECAUSE IT REQUIRES THE USE OF A UTILITY KNIFE AND A HOT GLUE GUN (OPTIONAL), ADULT SUPERVISION IS RECOMMENDED.

Materials

For the chamber:

- Empty copier paper box with lid
- Glovebox artwork
- Masking tape
- Scissors
- Utility knife
- Metal edge ruler
- 2 Pieces of 11 X 17 construction paper
- Pencil
- Heavy cardboard cutting surface
- Clear contact paper (optional)

For the lid:

- Copier paper box lid
- Clear, 2-inch packing tape
- 2 Overhead transparency sheets
- Ruler
- Duct tape
- Utility knife
- Scissors

For the gloves:

- 4 Jumbo plastic cups (32 oz)
- Thick rubber bands (size #64 or wider)
- Dish washing gloves (long)
- Disposable surgical gloves
- Utility knife
- Scissors

Optional:

- Tube socks
- Low-temperature glue gun
- Low-temperature glue sticks

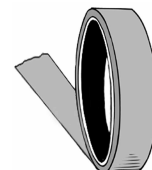
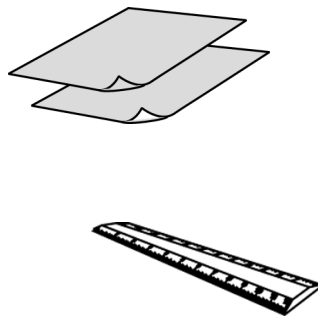
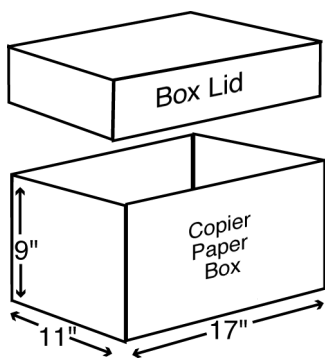

The Chamber

1. The picture on top shows the interior of the *Glovebox*. The lower picture is the exterior. Each picture has three sections: a long, middle section flanked by two shorter sides. Arrows indicate where to fold to form the side panels.
2. Cut out the interior and the exterior panels along the dotted lines. Leave the white border to fold over the sides.

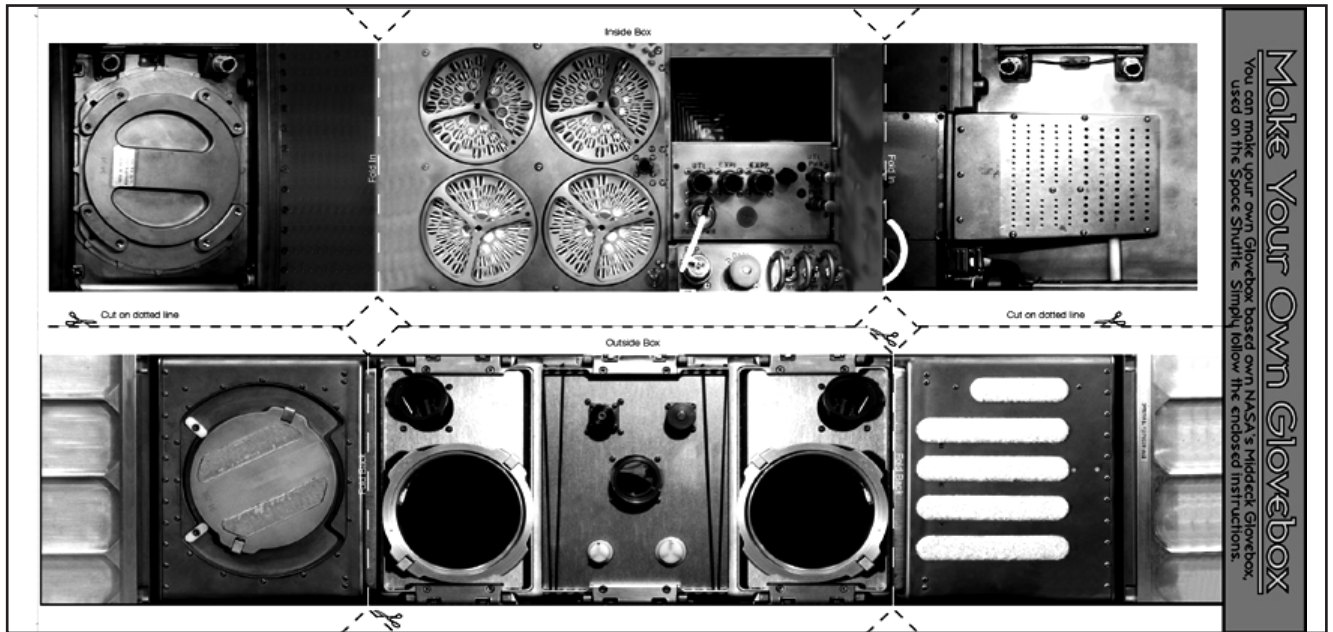

3. Fold the panels on the dotted lines as indicated.
4. Position the exterior middle segment so it fits the long side of the box. Use masking tape to secure the picture on the box, like you would wrap a present.
5. Position and secure the interior cutout to the inside of the box.

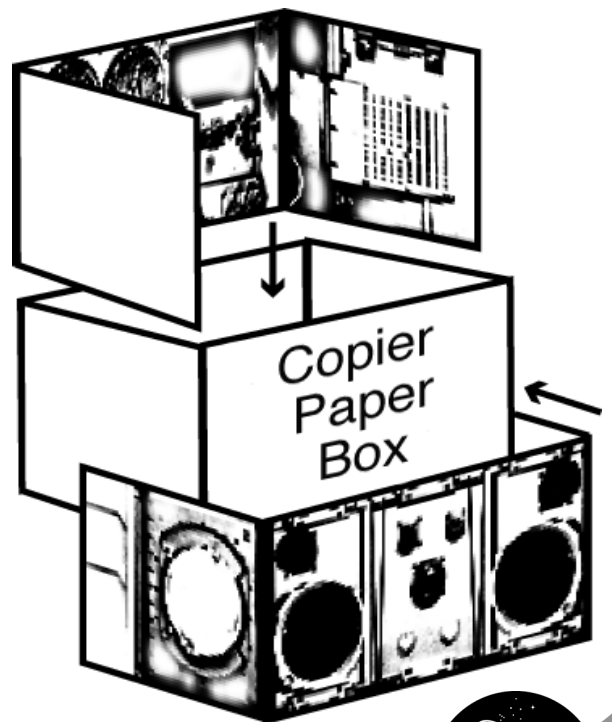

The Glove Inserts

1. Make two armhole rings by cutting two 32-oz, jumbo plastic cups 4.5 cm below the rim. Begin by cutting a slit with a utility knife, and finish cutting with scissors. Tape the jagged, cut edge with masking tape.

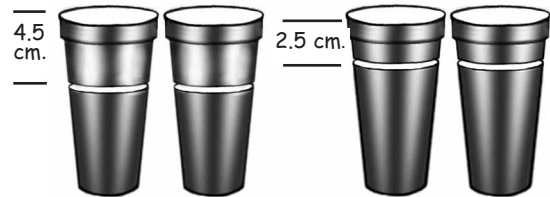

2. Cut two more cups 2.5 cm below the rim. Tape the edges. These rings will anchor the gloves inside the box.

3. Trace the inside rim of the jumbo plastic cup on the black glove holes. Use a utility knife to cut out the traced hole. The hole must be smaller than the diameter of the cup rim so the rim will not fall through the hole. Cover the ragged edges with short pieces of masking tape. **Note: YOU MAY WANT TO PRACTICE THIS PROCEDURE ON A SCRAP OF CARDBOARD FIRST, SO YOU DON'T RUIN THE GLOVEBOX.**

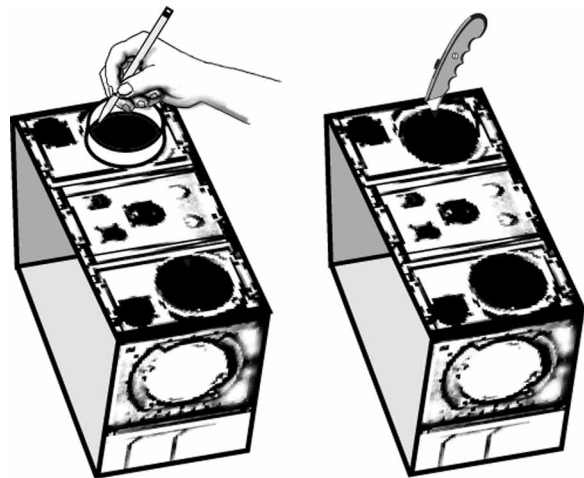

4. Pull the open end of a glove up through the taped side of the 4.5cm ring. Fold the cuff 2cm over the rim and secure it near the top with a thick rubber band.

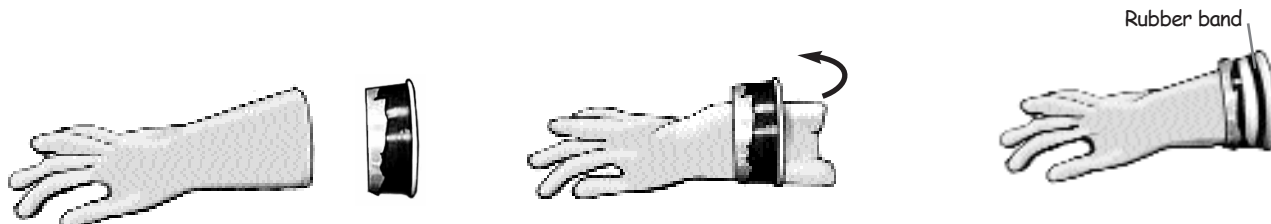

5. Insert the gloves through the box holes going into the chamber. The base of the gloves will NOT lie flush against the cardboard (5a.).
6. Press the armhole ring snugly into the box, a little bit at a time, until the glove is tightly nested in the cardboard (6a).
7. Pass the glove through the 2.5 cm anchor ring inside the box, and press securely, like cups stacked together (7a). You can make the cup fit more snugly by adding layers of tape. If they will not stay together, you may opt to hot glue the anchor rings to the glove rings. This, however, will prevent you from being able to try different kinds of gloves when working in the *Glovebox*.

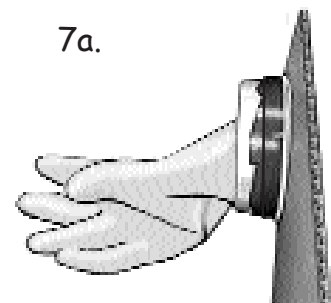
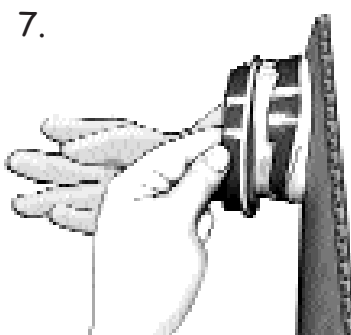
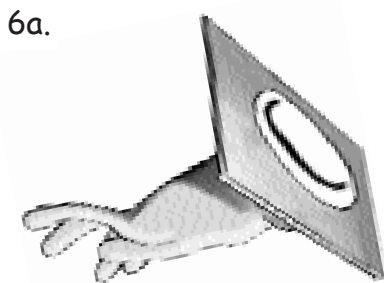
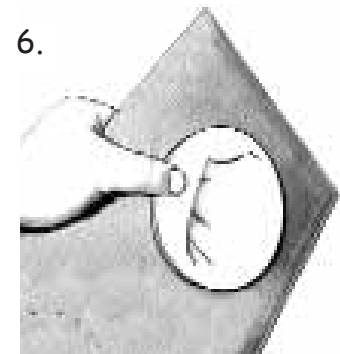
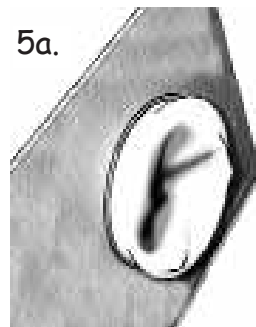
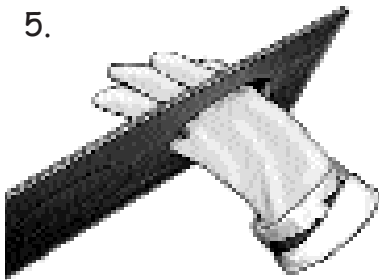

Different Glove Inserts (Optional)

Crew members can either use a heavy glove, thin surgical gloves, or their bare hands in the *Glovebox*. The choice depends on the type of experiment, the motor skills required, and the level of protection needed. The gloves fashioned in the previous directions are an example of heavier gloves used for more protection. If students cannot reach far enough into the *Glovebox*, a longer glove can be made. See the details below. For finer motor control, you can use surgical gloves by themselves or even wear surgical gloves over the rubber gloves for a better fit.

1. Make a cuff or covered opening for the armholes. Cut off the fingers and thumb of surgical gloves and fasten the remaining sleeve to the cup ring as instructed in step four. This leaves a "cuff" for the arms to go through and keeps materials from spilling out of the *Glovebox*. Then, you can wear surgical gloves.



Another alternative is to attach the surgical gloves to the cut end of a tube sock.

1. Cut the toe off a tube sock.
2. Make a hem with a hot glue gun to keep the edges from unraveling.
3. Hot glue the glove to the toe end of the sock.
4. Attach the other end of the sock to the cup ring with a thick rubber band, as in step four of the *Glove Insert* directions.

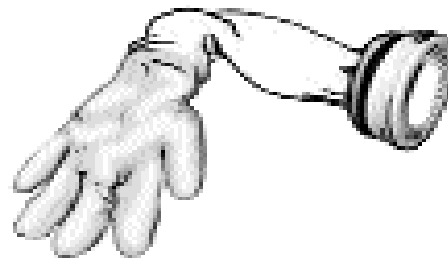

The Lid

1. Have a partner hold a ruler or meter stick firmly along the long-side of the lid, flush with the top, so the ruler will not wiggle. Use the utility knife to trim the lid lip to the width of the ruler. Repeat for the other three sides of the lid.
2. Draw and cut a window in the top of the lid with a border as wide as the ruler.
3. Place the lid upside down. Lay the transparency sheets side-by-side so they touch and cover the hole completely. Tape the sheets together with the clear packing tape. Secure the sheets to the lip of the border with tape.
4. Tape the rim of the lid with gray duct tape.

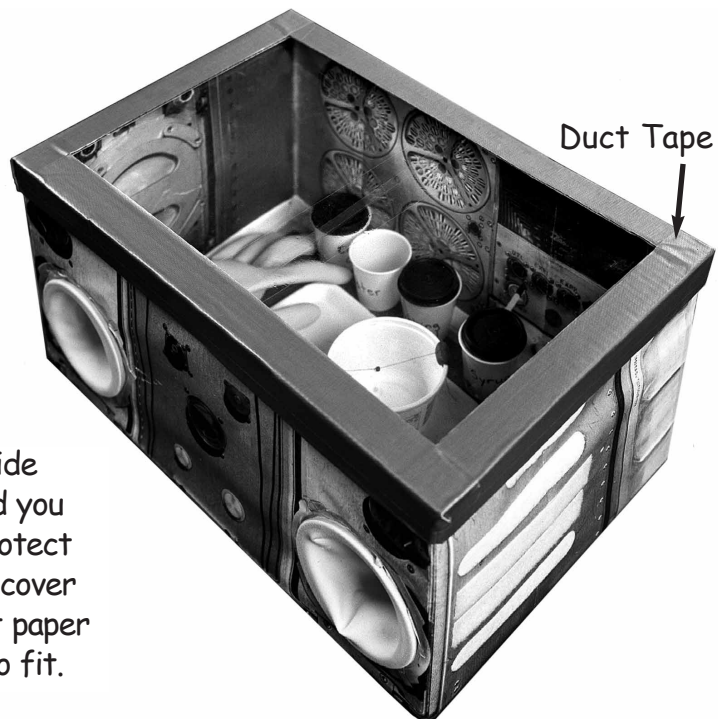
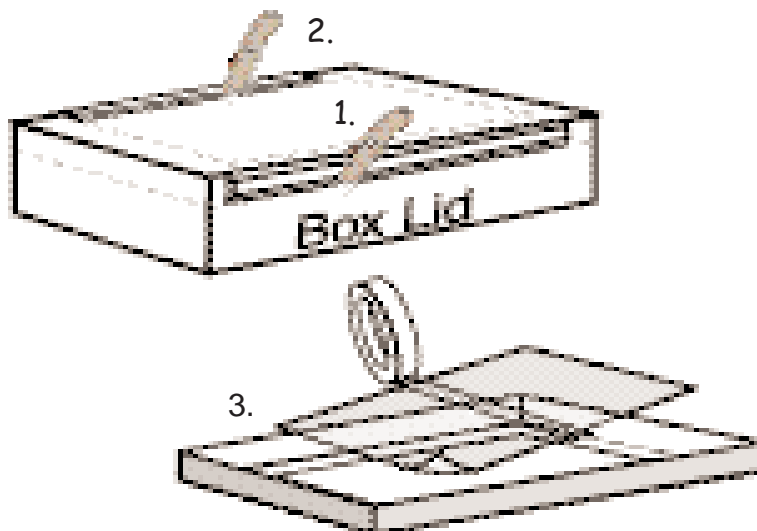

Optional: Tape construction paper to the inside bottom and the outside back of the box, and you have a completed classroom *Glovebox*. To protect the *Glovebox* from spills and wear and tear, cover the inside with clear contact paper. Contact paper is difficult to work with, so cut each piece to fit.



Droplet Investigation of Liquids (DIL)

This inquiry-based activity is based on a Glovebox investigation with the catchy title: Fiber Supported Droplet Combustion investigation, or FSDC for short. FSDC was performed on the Space Shuttle *Columbia* in 1995 and 1997 and will fly again aboard the *International Space Station*. The investigation studied ways to position droplets of liquid fuels on thin fibers and then ignite them on orbit. This research allowed scientists to develop efficient droplet deployment (positioning) techniques and to study droplet combustion processes. Such research may improve fuel efficiency and reduce pollution on Earth.

This student activity, the Droplet Investigation of Liquids (DIL) is based on the FSDC investigation, but without igniting the droplets. The purpose of DIL is to have students design their own experiment and in the process investigate characteristics of various liquids. The class can go one step further and speculate how their experiments would work on orbit, in a microgravity environment.

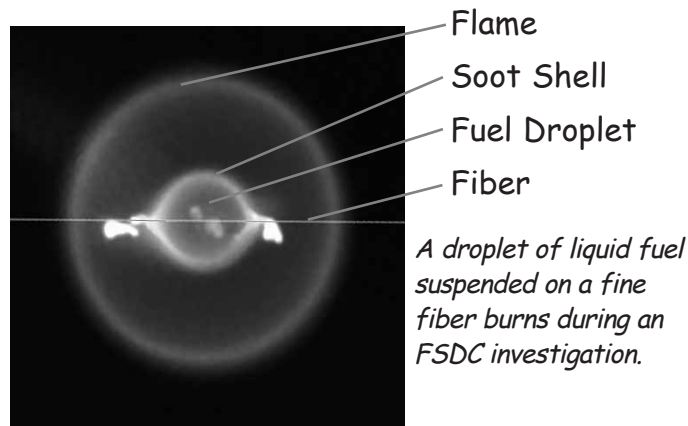

Objectives

The students will design their own DIL experiment and experiment hardware that can be used in their team's Glovebox. To conduct this activity, students will need to experiment with various fibers and liquids to determine which fiber and which liquid will produce the most spherical droplet. They will also need to figure out the best way to mount the fiber, write instructions to conduct the activity, and present their conclusions at a science conference.

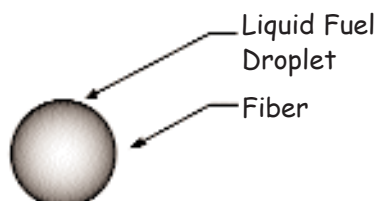

Students will test ways to deploy droplets of liquids on wires.

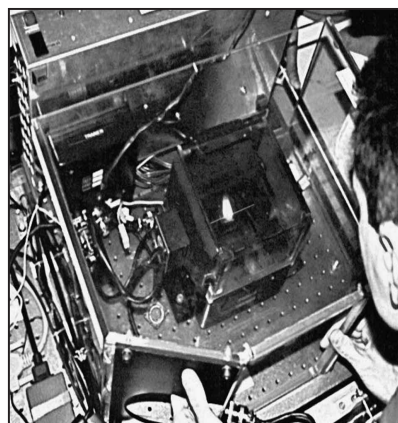

Payload Specialist Greg Linteris ignites a liquid fuel droplet using FSDC hardware during training aboard a research aircraft in preparation for a Shuttle mission.



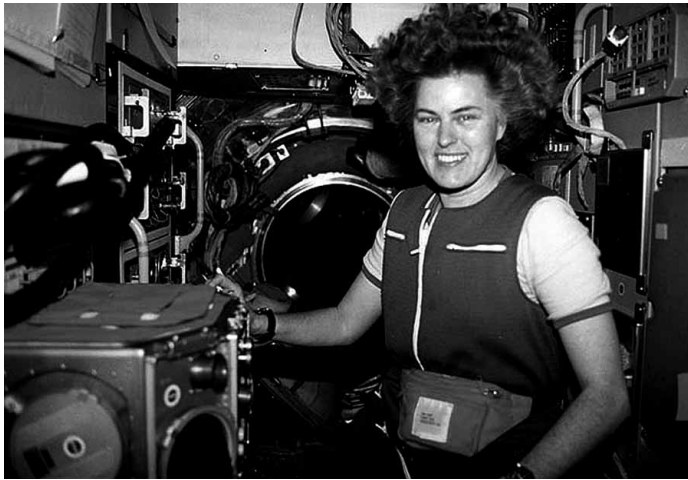

Board Engineer Shannon Lucid poses with the Glovebox onboard the Priroda module of the Russian Space Station Mir.

Materials

- Assorted fibers (waxed dental floss, unwaxed dental floss, jewelry wire, nylon fishing line, thread, string)
- Small containers to hold liquids (such as beakers, paper cups, film canisters, or yogurt containers)
- Materials to build experiment apparatus (like margarine tubs)
- Different liquids (like cooking oil, water, rubbing alcohol, and corn syrup)
- Scissors
- Velcro™
- Push pins and binder clips
- Plastic beads (small and very small)
- Eye droppers, pipettes, or needleless syringes (2 ml or less)
- Styrofoam meat trays or plates to catch spills
- Re-sealable bags (to store team materials)
- NASA Student Glovebox
- DIL Data Table worksheets (3 per student)
- Writing paper and pencils
- Paper towels
- Metal lunch box (optional)
- Instant or digital camera (optional)

NOTE: THE LIQUIDS AND FIBERS LISTED HERE ARE MERELY SUGGESTIONS. ENCOURAGE STUDENTS TO TRY OTHERS. IF YOU USE RUBBING ALCOHOL, BE SURE THE ROOM IS WELL VENTILATED.

Preparation

- Send a note home to parents telling them about the project a week or two ahead of time. Include the materials list and ask them to send in materials from this list.
- Discuss properties of liquids, such as how different liquids and materials interact, surface tension, and viscosity, so students will know what to look for while making observations.
- Review the scientific process and how to design an effective experiment. Go over ways to communicate data using tables and charts.



Procedure

1. Show students a NASA Student Glovebox. Describe the purposes for spacecraft Gloveboxes and how they work.
2. Explain the purpose of the FSDC investigation, and tell them they will be creating their own DIL investigation to determine which combination of liquids and fibers will produce the most spherical droplets, with the liquid evenly surrounding the fiber, like a bead. This simulates the Shuttle FSDC investigations, where scientists researched the best way to suspend various fuel droplets on a wire before igniting them. In this example, the Glovebox investigation is being used to test a technique and perfect hardware, as well as to gather data. Taking into account the physical characteristics of the liquid fuels is an essential element to the design.

3. Explain the DIL investigation requirements to your students.
 - Each team must build an apparatus or experiment hardware that can hold a piece of fiber taut. Creative use of technology and creative thinking are important.
 - Experiment hardware must fit inside of the metal lunch box to meet space limitations within the Glovebox.
 - The apparatus must be "Flight Safe." Remember, in low-Earth orbit equipment and tools need to be held in place. Liquids need to be contained.
 - Teams should make a technical drawing of the apparatus.
 - Each team will present one set of directions explaining how to conduct the experiment step by step. Accuracy, grammar, and neatness are signs of professionalism. Complete sentences are required.

4. On the first day, allow students to work individually or in small groups in a free-form investigation, testing liquids and fibers and building experiment hardware. Students should pay attention to the properties of the liquids and fibers. They have multiple liquids and fibers to test, but must limit their team's selection to three liquids and three fibers for testing on Day Two. Remind students to notice which liquids and fibers produce the most spherical droplets, with the liquid evenly surrounding the fiber, like a bead, and which fibers hold the droplets best.
5. Students should make careful, critical observations, not assumptions. Accurate drawings are the key for making comparisons. At first, students may think droplets are all spherical. Show them this diagram to see the many shapes droplets may take. Taking pictures may help with comparisons.

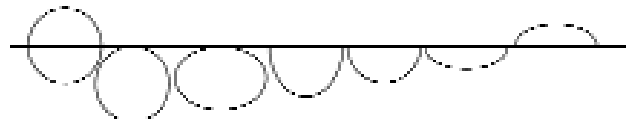

6. Scientists sometimes use tiny, hollow spherical balls to anchor droplets of liquid fuel to a wire. Have students try different ways to anchor a droplet, like a bead or a knot, and choose one method to test in the next class, as indicated on the worksheet.
7. Ask students what roles surface tension and viscosity play in this investigation.
8. Ask leading questions to help students determine what design approach to take for the experiment hardware. How will they start? What do they need to know to build the apparatus? How will they know if the design is successful? How will they make their hardware flight safe?



- 9.(Optional) As a class, develop a rubric to determine their final grade, including experiment drawing design, written procedures, droplet characteristics, data collection, conclusions, and a presentation at the Glovebox Research Conference.
- 10.On Day Two, students should work in groups of four or five, at the teacher's discretion. Team members should share their findings from the previous day's investigation. They should review the requirements of the DIL experiment before selecting the three fibers and three liquids to officially use in their Glovebox investigation.
- 11.Each team member is responsible for ideas and contributions. When they are ready for testing, team members should assume the roles of:
- Principal Investigator - Writes and reads the experiment procedures.
 - Technical Lead - Builds the apparatus, makes it flight safe.
 - Crew Member - Conducts the investigation, following written experiment procedures.
 - Project Manager - Observes and records what happens on the data sheet, and keeps the team on schedule.
- 12.Once they decide on their roles, the team should work on the experiment hardware design, meeting flight safety requirements, and start testing liquids and fibers, using the worksheet.
- 13.Let students work in teams independently over one or two class periods. Monitor their progress, making sure they do not spend too long on any one step. Each day the Project Manager should share progress and problems with the teacher.
- 14.Teams should analyze their data and select the best fiber, liquid, and anchor for their DIL investigation. After finalizing their drawings and written procedures, each team should submit one set to the teacher.
- 15.Once approved, teams should test their DIL investigation and complete the worksheet. They should note the following:
- Does their apparatus meet the DIL investigation requirements?
 - Did their flight hardware work according to plan or did it require modifications?
 - How did the experiment meet flight safety requirements?
 - Were the written instructions easy to follow, or were revisions necessary?



Payload Specialist Albert Sacco, Jr. works in the Glovebox on the Shuttle.

- 16.Place experiment hardware in the NASA Student Glovebox and test it to see how it works. How was working in the Glovebox different from working in an open laboratory? What kind of gloves did the team use? Why? How could crew members get a better view inside the Glovebox?
- 17.Hold a Glovebox Research Conference where teams present their conclusions using data tables and charts to support their findings.



Conference Discussion Questions

Each team member needs to be prepared to answer all of the following questions.

- What made your hardware design work well?
- What liquids and fibers produced the most spherical droplets? *See answer key question 3.*
- Based on your observations, predict which liquids have the lowest to highest surface tension? *See answer key question 4.*
- How well did your group work as a team? What made this team project challenging?
- What did you learn about conducting a scientific investigation?
- How would you improve the way you conducted this investigation if you could do it again?
- How could you make your data collection more precise?
- Do you think your team's results are reproducible? Explain.
- Would you feel comfortable designing and conducting an investigation of your own, if asked? Why or why not?

Think!

Were the majority of the droplets suspended evenly on the fibers? *No.* Would this be an issue if the investigation flew on the *International Space Station*? *No.* Gravity will not pull the drops down in an orbiting spacecraft, so tear-shaped droplets become round, as surface tension becomes the dominant force at work. Droplets will no longer "hang down," because there is no down, but hang around the fiber more evenly.

Answer Key to Droplet Investigation of Liquids (DIL) Data Table

Data Table

The following is an **example** of how a student **might** complete part of the data table, minus the drawings. The results depend on the fluids and fibers selected, the type of dropper, the anchor method, and the skills of the student. Answers will vary.

Fiber Type	Anchor Method Small Bead	Predict	Plain Fiber	How did the fluid interact with the fiber?
<i>Waxed Dental Floss</i>	<i>Two droplets hung from the bottom of the bead.</i>	<i>A big round droplet will lay on top of the floss, like water beads on wax paper.</i>	<i>Droplet would not stick to the floss.</i>	<i>Water sticks to itself and bounces off the waxed floss. This would not be a good fiber to use in the Glovebox.</i>

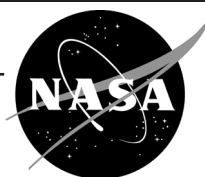

Worksheet Answer Key (Note: for all questions, expect answers to vary. These are possible answers from our tests, not definitive answers.)

Question 1: Characteristics of Liquids

Canola Oil - Pale yellow, thicker liquid than water, surface tension is less than water, coats most fibers except for wire.

Corn Syrup - Thick, tacky, pale yellow, moves slowly, high viscosity, so heavy it rolls off fibers, holds shape well, forms best spheres.

Rubbing Alcohol - Stinky, thin liquid, has low surface tension, evaporates quickly, forms unstable droplets, absorbs into cotton and twine.

Water - Has high surface tension, clear, absorbs into cotton and twine, does not interact with wire, bounces off of wax.

Question 2: Anchors

For each fiber, we used the following anchor methods: no anchor, a knot, a small bead, and a large bead. We even tried a drop of super glue as an anchor, which was a total mess. Don't use it! The knot and the smaller beads acted as better anchors for droplets.

Water - Water droplets clung to the bead but not the fiber. The knot did anchor a droplet to the unwaxed floss.

Oil - The oil acts the same on the bead regardless of the fiber used, coating the bead completely. With time the droplet hangs more from the bottom of the bead.

Alcohol - For both flosses, the bead provided a good anchor, otherwise, alcohol did not form much of a droplet on the various fibers.

Corn Syrup - Corn syrup formed droplets on the knots of the waxed and unwaxed floss. The syrup anchors to the bead, not the fibers.

Question 3: Most Spherical Droplets

We tested corn syrup, canola oil, rubbing alcohol, and water using waxed and unwaxed dental floss, fine jewelry wire, cotton sewing thread, nylon fishing line, and twine. Here's our ranked list of the combinations for the most spherical droplets, from most to least spherical.

1. Corn syrup and nylon fishing line or unwaxed floss - By far the most spherical droplets resulted from the corn syrup on the plain nylon fishing line, and next best on the unwaxed dental floss. Corn syrup was also the most interesting liquid to observe because it is so viscous. Droplets held their shape even if the fiber was held vertically.
2. Water and cotton sewing thread - Water has the highest surface tension of the liquids we tested. Fibers with plastic bead anchors could hold up to two droplets; however, the shape was not spherical.
3. Canola oil and nylon fishing line - Oil on the knot of the nylon fishing line produced a small semi-spherical droplet. Single drops formed below most plain fibers once the fiber was coated with oil. Small droplets hung from the bottom of the beads for all of the fibers.
4. Rubbing alcohol - On the knot of the nylon fishing line and fine jewelry wire, alcohol produced the smallest droplets, and it formed the least spherical droplets.



Question 4: Surface Tension

From lowest to highest surface tension: (1) alcohol, (2) corn syrup, (3) canola oil, (4) water. Students may notice surface tension by the way a liquid seems to "stick" to itself and the way it interacts with fibers. Water has the greatest surface tension of these liquids, forming the largest droplets. As a droplet falls, it forms a sphere. Drops of water suspended from a dropper seem to bounce off waxed floss. In contrast, alcohol forms the smallest droplets, and does not cling well to fibers.

Question 5: Viscosity

From lowest to highest viscosity: (1) alcohol, (2) water, (3) canola oil, (4) corn syrup. Corn syrup forms spherical little balls that keep their shape, even when the string dangles. When corn syrup drips, it may form runny tails.

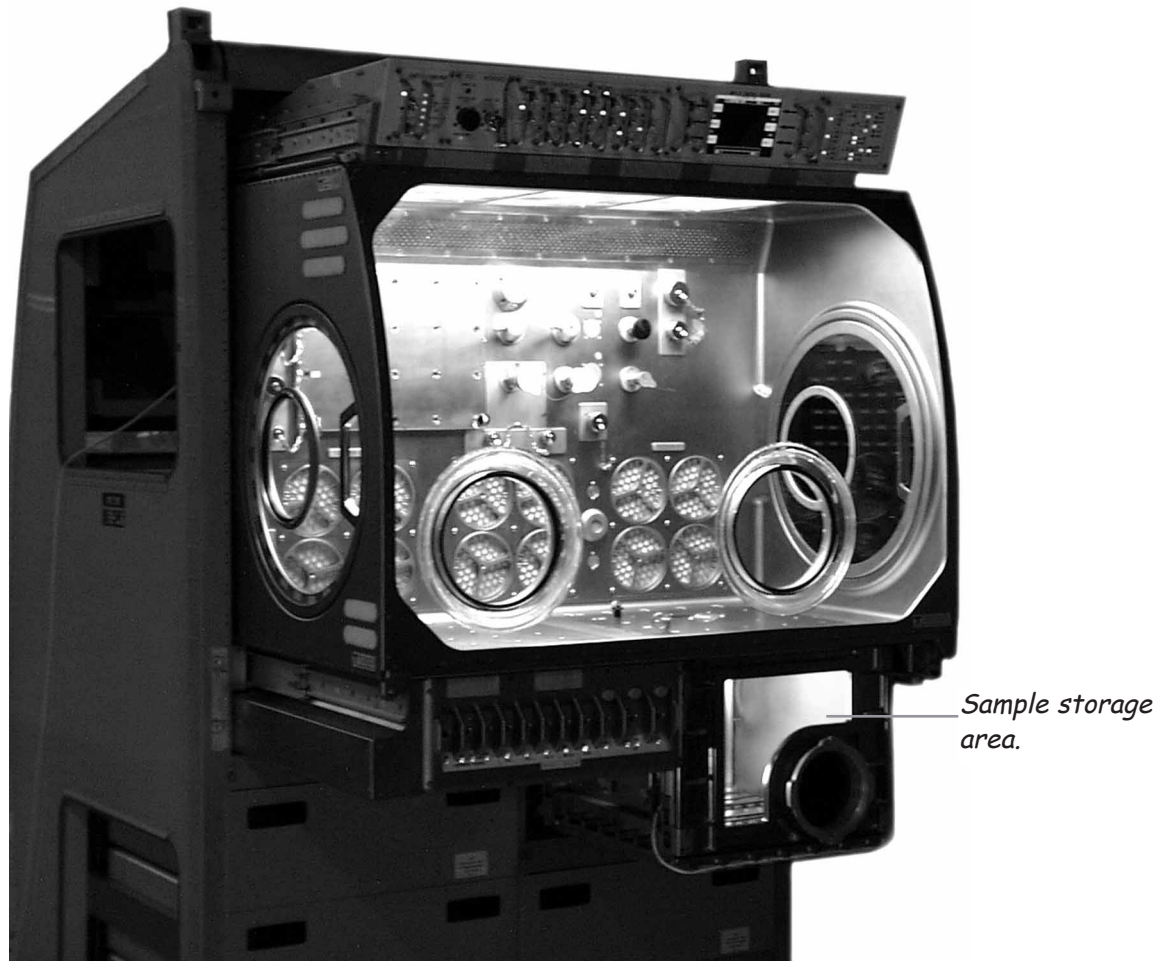







The International Space Station (ISS) Glovebox is larger and has more capabilities than Shuttle Gloveboxes. In fact, the entire Shuttle Glovebox is about as big as the sample storage area of the ISS Glovebox.

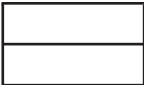

Droplet Investigation of Liquid (DIL) Data Table

Liquid _____

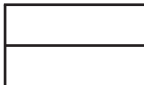
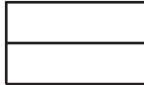
Fiber Type <small>List the fiber type.</small>	Anchor Method	Predict <small>Predict how the liquid will interact with the fiber. Draw droplet shape and size in the small box. The line represents the fiber.</small>	Plain Fiber <small>Draw droplet shape and size in the small box. The line represents the fiber.</small>	How did the fluid interact with the fiber?
				
				
				



Websites

For more information about NASA Gloveboxes, Glovebox research, and related education materials, visit these websites.

General Microgravity Glovebox Information

<http://microgravity.nasa.gov/Glov.html>
<http://microgravity.grc.nasa.gov/expr2/gb.htm>
<http://spacelink.nasa.gov> (Do a search for Glovebox.)

Glovebox Overheads

<http://www.ncmr.org/education/k12/overheads.html>

Fiber Supported Droplet Combustion Investigation

<http://zeta.grc.nasa.gov/expr2/fsdc.htm>

Microgravity Education Materials

<http://www.ncmr.org/education/k12/classroom.html>
<http://spacelink.nasa.gov>

Microgravity Mission Information

<http://microgravity.nasa.gov>

Microgravity Images

<http://microgravity.nasa.gov/MGImages/UTILS/search.mg1.cgi>

NASA Education Materials and Programs

<http://spacelink.nasa.gov>
<http://education.nasa.gov>



Payload Specialist Larry DeLucas uses a Glovebox as part of ground training before a Shuttle mission.

Microgravity Glovebox Missions

Note: If the mission websites do not work, chances are good that the site was moved to an archive somewhere. Don't give up! Try doing a search for the mission acronym (such as USML-2) at <http://spaceflight.nasa.gov>

USML-2

<http://liftoff.msfc.nasa.gov/shuttle/usml2/>

USMP-3

<http://microgravity.grc.nasa.gov/usmp3/usmp3.htm>

USMP-4

<http://science.msfc.nasa.gov/usmp4/usmp4.htm>

MSL-1

<http://spaceflight.nasa.gov/shuttle/archives/sts-83/presskit/msl1/glovebox/>

Shuttle/Mir Microgravity Experiments

<http://spaceflight.nasa.gov/history/shuttle-mir/science/shuttmir/shutmir/microexp.htm>

Spacelab

<http://liftoff.msfc.nasa.gov/shuttle/spacelab/sl-hist.html>

International Space Station

<http://spaceflight.nasa.gov/station/index.html>
<http://observe.ivv.nasa.gov/nasa/core.html>
<http://liftoff.msfc.nasa.gov/temp/StationLoc.html>
<http://spaceflight.nasa.gov/gallery/images/station>



NASA Educator Resource Centers

NASA's Central Operation of Resources for Educators (CORE) was established for the national and international distribution of NASA-produced educational materials in audiovisual format. Educators can obtain a catalogue and an order form by one of the following methods:

NASA CORE

Lorain County Joint Vocational School
 15181 State Route 58
 Oberlin, OH 44074-9799
 Phone: (440) 775-1400
 Fax: (440) 775-1460
 E-mail: nasaco@leeca.org
 Home Page: <http://core.nasa.gov>

Educator Resource Center Network (ERCN)

To make additional information available to the education community, NASA has created the NASA Educator Resource Center (ERC) network. Educators may preview, copy, or receive NASA materials at these sites. Phone calls are welcome if you are unable to visit the area. A list of the centers and the regions they serve follows.

If you live in:	Please contact:
Alaska Arizona California Hawaii Idaho Montana Nevada Oregon Utah Washington Wyoming	NASA Educator Resource Center Mail Stop 253-2 NASA Ames Research Center Moffett Field, CA 94035-1000 Phone: (650) 604-3574 FAX: (650) 604-3445 http://ccf.arc.nasa.gov/dx/basket/trc/trchome.html
Illinois Indiana Michigan Minnesota Ohio Wisconsin	NASA Educator Resource Center NASA John H. Glenn Research Center at Lewis Field 21000 Brookpark Rd., MS 8-1 Cleveland, OH 44135 Phone: (216) 433-2017 FAX: (216) 433-3601 http://www.grc.nasa.gov/WWW/PAO/html/edteacher.htm



<p>Connecticut Delaware District of Columbia Maine, Maryland Massachusetts Pennsylvania New Hampshire New Jersey New York Rhode Island Vermont</p>	<p>NASA Educator Resource Laboratory Mail Code 130.3 NASA Goddard Space Flight Center Greenbelt, MD 20771-0001 Phone: (301) 286-8570 FAX: (301) 286-1781 http://pao.gsfc.nasa.gov/gsfc/educ/tri/welcome.html</p>
<p>Colorado Kansas Nebraska New Mexico North Dakota Oklahoma South Dakota Texas</p>	<p>Space Center Houston NASA Educator Resource Center for Johnson Space Center 1601 NASA Road One Houston, TX 77058 Phone: (281) 244-2129 FAX: (281) 483-9638 http://www.jsc.nasa.gov</p>
<p>Florida Georgia Puerto Rico Virgin Islands</p>	<p>NASA Educator Resource Center Mail Code ERC NASA Kennedy Space Center J.F. Kennedy Space Center, FL 32899 Phone: (321) 867-4090 FAX: (321) 867-7242 http://www/ksc.nasa.gov</p>
<p>Kentucky North Carolina South Carolina Virginia West Virginia</p>	<p>Virginia Air and Space Center Educator Resource Center for NASA Langley Research Center 600 Settlers Landing Road Hampton, VA 23669-4033 Phone: (757) 727-0990 Ext. 75 FAX: (757) 727-0898 http://www.vasc.org/erc/</p>
<p>Alabama Arkansas Louisiana Missouri Tennessee Iowa</p>	<p>U.S. Space & Rocket Center Educator Resource Center for NASA Marshall Space Flight Center One Tranquility Base Huntsville, AL 35758 Phone: (256) 544-5812 FAX: (256) 544-5820 http://www.msfc.nasa.gov/education/erc</p>



Mississippi	NASA Educator Resource Center NASA Stennis Space Center Building 1200 Stennis Space Center, MS 39529-6000 Phone: (228) 688-3220 FAX: (228) 688-2824 http://education.scc.nasa.gov/htmls/trc/trc.htm
The Jet Propulsion Laboratory (JPL) serves inquiries related to space and planetary exploration and other JPL activities.	NASA JPL Educator Resource Center Village at Indian Hill 1460 East Holt Avenue, Suite 20 NASA Jet Propulsion Laboratory Pomona, CA 91767 Phone: (909) 397-4420 Fax: (909) 397-4470 http://learn.jpl.nasa.gov
Arizona and Southern California	NASA Educator Resource Center for NASA Dryden Flight Research Center 45108 N. 3rd Street East Lancaster, CA 93535 Phone: (661) 948-7347 Fax: (661) 948-7068 http://www.dfrc.nasa.gov/trc/
Virginia and Maryland's Eastern Shores	GSFC/Wallops Flight Facility NASA Educator Resource Center Building J-17 Wallops Island, VA 23337 Phone: (757) 824-2298 FAX: (757) 824-1776 http://WFF.nasa.gov

Regional Educator Resource Centers offer more educators access to NASA educational materials. NASA has formed partnerships with universities, museums, and other educational institutions to serve as regional ERCs in many states. A complete list of regional ERCs is available through CORE, or electronically via NASA Spacelink at **<http://spacelink.nasa.gov/ercn/>**

NASA's Education Home Page serves as a cyber-gateway to information regarding educational programs and services offered by NASA for the American education community. This high-level directory of information provides specific details and points of contact for all of NASA's educational efforts, Field Center offices, and points of presence within each state. Visit this resource at the following address: **<http://education.nasa.gov>**



Spacelink

NASA Spacelink is one of NASA's electronic resources specifically developed for the educational community. Spacelink is a "virtual library" in which local files and hundreds of NASA World Wide Web links are arranged in a manner familiar to educators. Using the Spacelink search engine, educators can search this virtual library to find information regardless of its location within NASA. Special events, missions, and intriguing NASA websites are featured in Spacelink's "Hot Topics" and "Cool Picks" areas. Spacelink may be accessed at:
<http://spacelink.nasa.gov>

NASA Spacelink is the official home to electronic versions of NASA's Educational Products. A complete listing of NASA Educational Products can be found at the following address:
<http://spacelink.nasa.gov/products>

NASA Television (NTV) features Space Shuttle mission coverage, live special events, interactive educational live shows, electronic field trips, aviation and space news, and historical NASA footage. Programming has a 3-hour block — Video (News) File, NASA Gallery, and Education File — beginning at noon Eastern and repeated five more times throughout the day. Live feeds preempt regularly scheduled programming.

Check the Internet for program listings at:
<http://www.nasa.gov/ntv>

For more information on NTV, contact:
NASA TV
NASA Headquarters
Code P-2
Washington, DC 20546-0001
Phone (202) 358-3572

NTV Weekday Programming Schedules (Eastern Times)

Video File	NASA Gallery	Education File
12-1 p.m.	1-2 p.m.	2-3 p.m.
3-4 p.m.	4-5 p.m.	5-6 p.m.
6-7 p.m.	7-8 p.m.	8-9 p.m.
9-10 p.m.	10-11 p.m.	11-12 p.m.

How to Access Information on NASA's Education Program, Materials, and Services EP-1999-06-345-HQ.

This brochure serves as a guide to accessing a variety of NASA materials and services for educators. Copies are available through the ERC network, or electronically via NASA Spacelink.

Online Evaluation

Please take a moment to evaluate this product at
http://ehb2.gsfc.nasa.gov/edcats/educators_guide.
Your evaluation and suggestions are vital to continually improving
NASA educational materials.

Thank you.



NASA's Student Glovebox: An Inquiry-Based Technology Educator's Guide

EDUCATOR REPLY CARD

To achieve America's goals in Educational Excellence, it is NASA's mission to develop supplementary instructional materials and curricula in science, mathematics, and technology. NASA seeks to involve the educational community in the development and improvement of these materials. Your evaluation and suggestions are vital to continually improving NASA educational materials.

Please take a moment to respond to the statements and questions below. You can submit your response through the Internet or by mail. Send your reply to the following Internet address:

http://ehb2.gsfc.nasa.gov/edcats/educator_guide

You will then be asked to enter your data at the appropriate prompt.

Otherwise, please return the reply card by mail. Thank you.

- With what grades did you use the educator guide?
 Number of Teachers/Faculty:
 ___ K-4 ___ 5-8 ___ 9-12 ___ Community College
 College/University - ___ Undergraduate ___ Graduate
 Number of Students:
 ___ K-4 ___ 5-8 ___ 9-12 ___ Community College
 College/University - ___ Undergraduate ___ Graduate
 Number of Others:
 ___ Administrators/Staff ___ Parents ___ Professional Groups
 ___ General Public ___ Civic Groups ___ Other
- What is your home 5- or 9-digit zip code? _____
- This is a valuable educator guide?
 Strongly Agree Agree Neutral Disagree Strongly Disagree
- I expect to apply what I learned in this educator guide.
 Strongly Agree Agree Neutral Disagree Strongly Disagree

Fold along line and tape closed.

5. What kind of recommendation would you make to someone who asks about this educator guide?

- Excellent Good Average Poor Very Poor

6. How did you use this educator guide?

- Background Information Critical Thinking Tasks
 Demonstrate NASA Materials Demonstration
 Group Discussions Hands-On Activities
 Integration Into Existing Curricula Interdisciplinary Activity
 Lecture Science and Mathematics
 Team Activities Standards Integration
 Other: Please specify: _____

7. Where did you learn about this educator guide?

- NASA Educator Resource Center
 NASA Central Operation of Resources for Educators (CORE)
 Institution/School System
 Fellow Educator
 Workshop/Conference
 Other: Please specify: _____

8. What features of this educator guide did you find particularly helpful?

9. How can we make this educator guide more effective for you?

10. Additional comments:

Today's Date: _____ **EG-2000-09-004-GRC**



Please Place
Stamp Here
Post Office
Will Not Deliver
Without Proper
Postage

**NATIONAL AERONAUTICS AND SPACE ADMINISTRATION
EDUCATION DIVISION
MAIL CODE FE
WASHINGTON DC 20546-0001**



Fold along line and tape closed.