

Teacher Information

Paper Rockets

Objective:

To design, construct, and fly paper rockets that will travel the greatest distance possible across a floor model of the solar system.

Description:

In this activity, students construct small flying rockets out of paper and propel them by blowing air through a straw.

Science Standards:

- Science as Inquiry
- Physical Science - Position and motion of objects
- Science and Technology - Abilities of technological design
- Unifying Concepts and Processes - Evidence, models, and explanation

Science Process Skills:

- Observing
- Communicating
- Measuring
- Collecting Data
- Inferring
- Predicting
- Making Models
- Interpreting Data
- Controlling Variables
- Defining Operationally
- Investigating

Mathematics Standards:

- Mathematics as Problem Solving
- Mathematics as Reasoning
- Mathematical Connections
- Geometry and Spatial Sense
- Statistics and Probability

Management:

After demonstrating a completed paper rocket to the students, have them construct their own paper rockets and decorate them. Students may work individually or in pairs.

- ★ Because the rockets are projectiles, make sure students wear eye protection.

Materials and Tools:

- Scrap bond paper
- Cellophane tape
- Scissors
- Sharpened fat pencil
- Milkshake straw (slightly thinner than pencil)
- Eye protection
- Metric ruler
- Masking tape or Altitude trackers
- Pictures of the Sun and planets

When students complete the rockets, distribute straws. Select a location for flying the rockets. A room with open floor space or a hallway is preferable. Prepare the floor by marking a 10-meter test range with tape measures or meter sticks laid end to end. As an alternative, lay out the planetary target range as shown on the next page. Have students launch from planet Earth, and tell them to determine the farthest planet they are able to reach with their rocket. Use the planetary arrangement shown on the next page for laying out the launch range. Pictures for the planets are found on page 63. Enlarge these pictures as desired.

Record data from each launch on the Paper Rocket Launch Record Report form. The form includes spaces for data from three different rockets. After the first launches,



students should construct new and "improved" paper rockets and attempt a longer journey through the solar system. Encourage the students to try different sized rockets and different shapes and number of fins. For younger students, create a chart listing how far each planet target is from Earth. Older students can measure these distances for themselves.

Background Information:

Although the activity uses a solar system target range, the Paper Rockets activity demonstrates how rockets fly through the atmosphere. A rocket with no fins is much more difficult to control than a rocket with fins. The placement and size of the fins is critical to achieve adequate stability while not adding too much weight. More information on rocket fins can be found on pages 22-23 of this guide.

Making and Launching Paper Rockets:

1. Distribute the materials and construction tools to each student.
2. Students should each construct a rocket as shown in the instructions on the student sheet.
3. Tell students to predict how far their rocket will fly and record their estimates in the test report sheet. After test flying the rocket and measuring the distance it reached, students should record the actual distance and the difference between predicted and actual distances on the Paper Rockets Test Report.
4. Following the flight of the first rocket, students should construct and test two additional rockets of different sizes and fin designs.

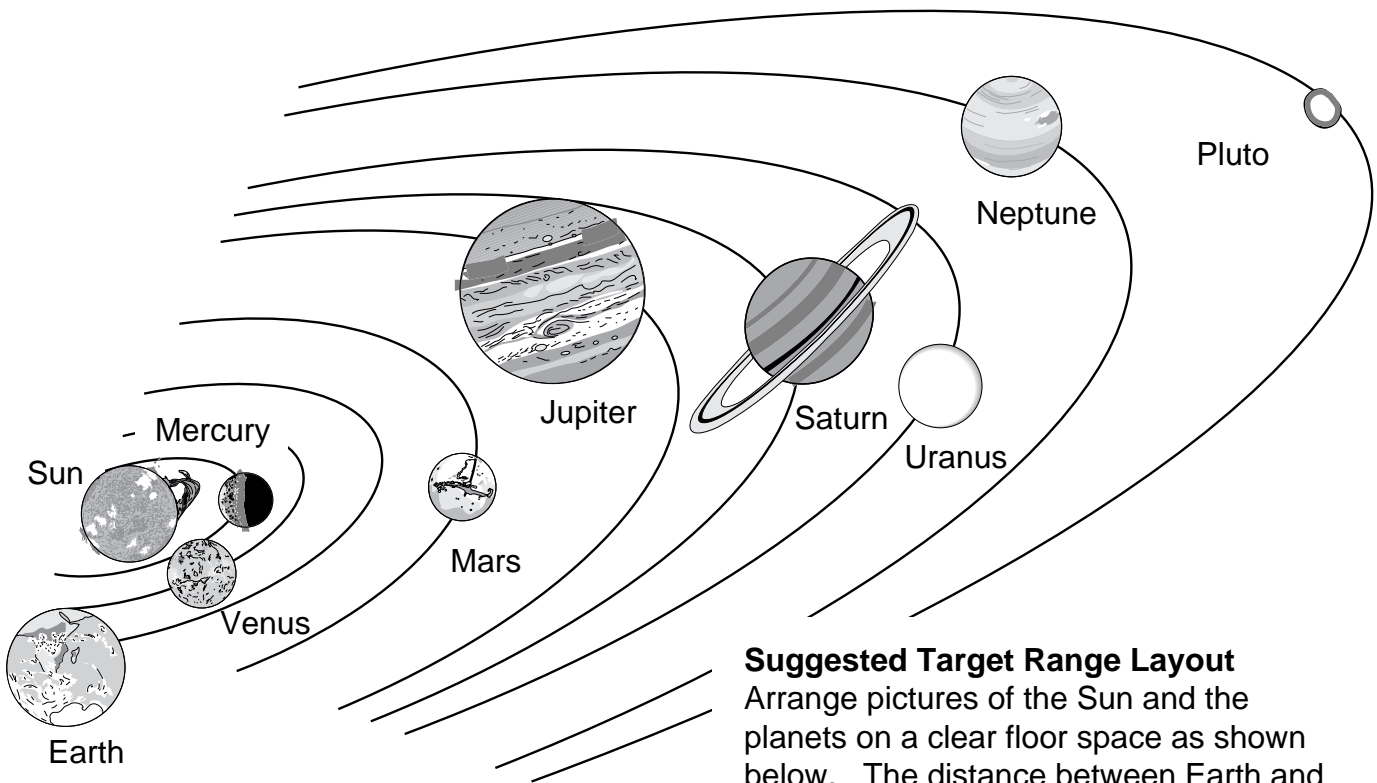

Suggested Target Range Layout

Arrange pictures of the Sun and the planets on a clear floor space as shown below. The distance between Earth and Pluto should be about 8 meters. Refer to an encyclopedia or other reference for a chart on the actual distances to each planet.



Planet Targets

(Not Drawn To Scale)

Enlarge these pictures on a copy machine or sketch copies of the pictures on separate paper. Place these pictures on the floor according to the arrangement on the previous page. If you wish to make the planets to scale, refer to the numbers beside the names indicating the relative sizes of each body. Earth's diameter is given as one and all the other bodies are given as multiples of one.

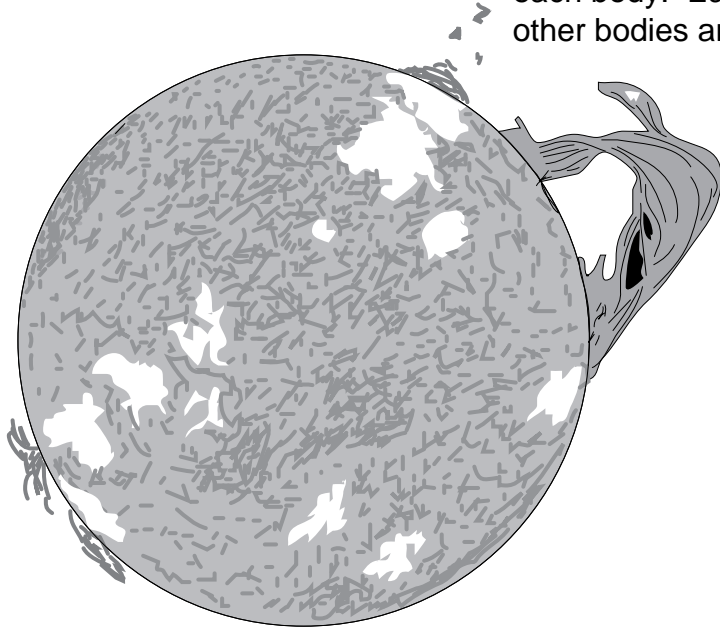

Sun
108X

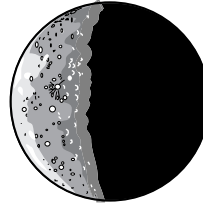

Mercury
0.38X



Venus
0.95X

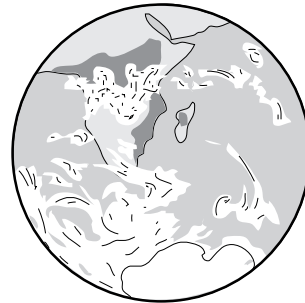

Earth
1X

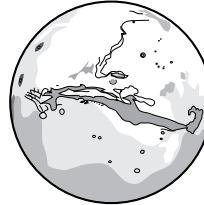

Mars
0.53X

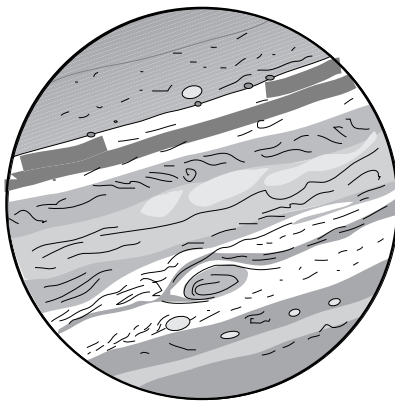

Jupiter
11.2X

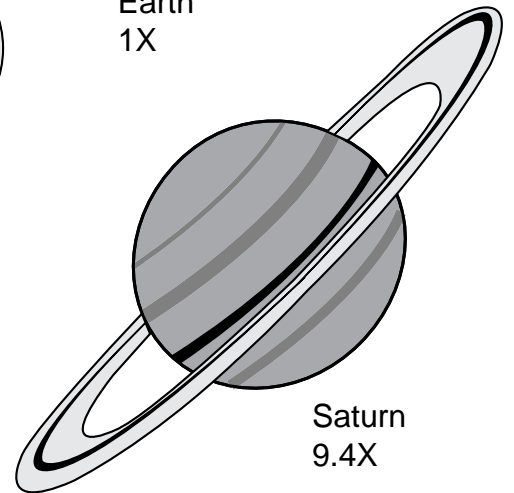

Saturn
9.4X

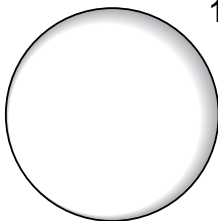

Uranus
4X

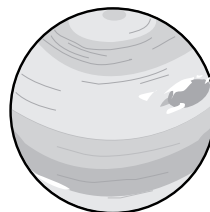

Neptune
3.9X



Pluto
0.9X



Discussion:

1. What makes one rocket perform better than another? (Do not forget to examine the weight of each rocket. Rockets made with extra tape and larger fins weigh more.)
2. How small can the fins be and still stabilize the rocket?
3. How many fins does a rocket need to stabilize it?
4. What would happen if you placed the rocket fins near the rocket's nose?
5. What will happen to the rocket if you bend the lower tips of the fins pinwheel fashion?
6. Are rocket fins necessary in outer space?

Extensions:

Try to determine how high the rockets fly. To do so, place masking tape markers on a wall at measured distances from the floor to the ceiling. While one student launches the rocket along the wall, another student compares the height the rocket reached with the tape markers. Be sure to have the students subtract the height from where the rocket was launched from the altitude reached. For example, if students held the rocket 1.5 meters from the floor to launch it, and it reached 4 meters above the floor, the actual altitude change was 2.5 meters. Refer to the Altitude Tracker activity starting on page 69 for details on a second method for measuring the height the paper rockets reach.

Assessment:

Students will complete test reports that will describe the rockets they constructed and how those rockets performed. Ask the students to create bar graphs on a blank sheet of paper that show how far each of the three rockets they constructed flew. Have students write a summarizing paragraph in which they pick which rocket performed the best and explain their ideas for why it performed as it did.



PAPER ROCKETS

Follow the arrows to build your rocket.

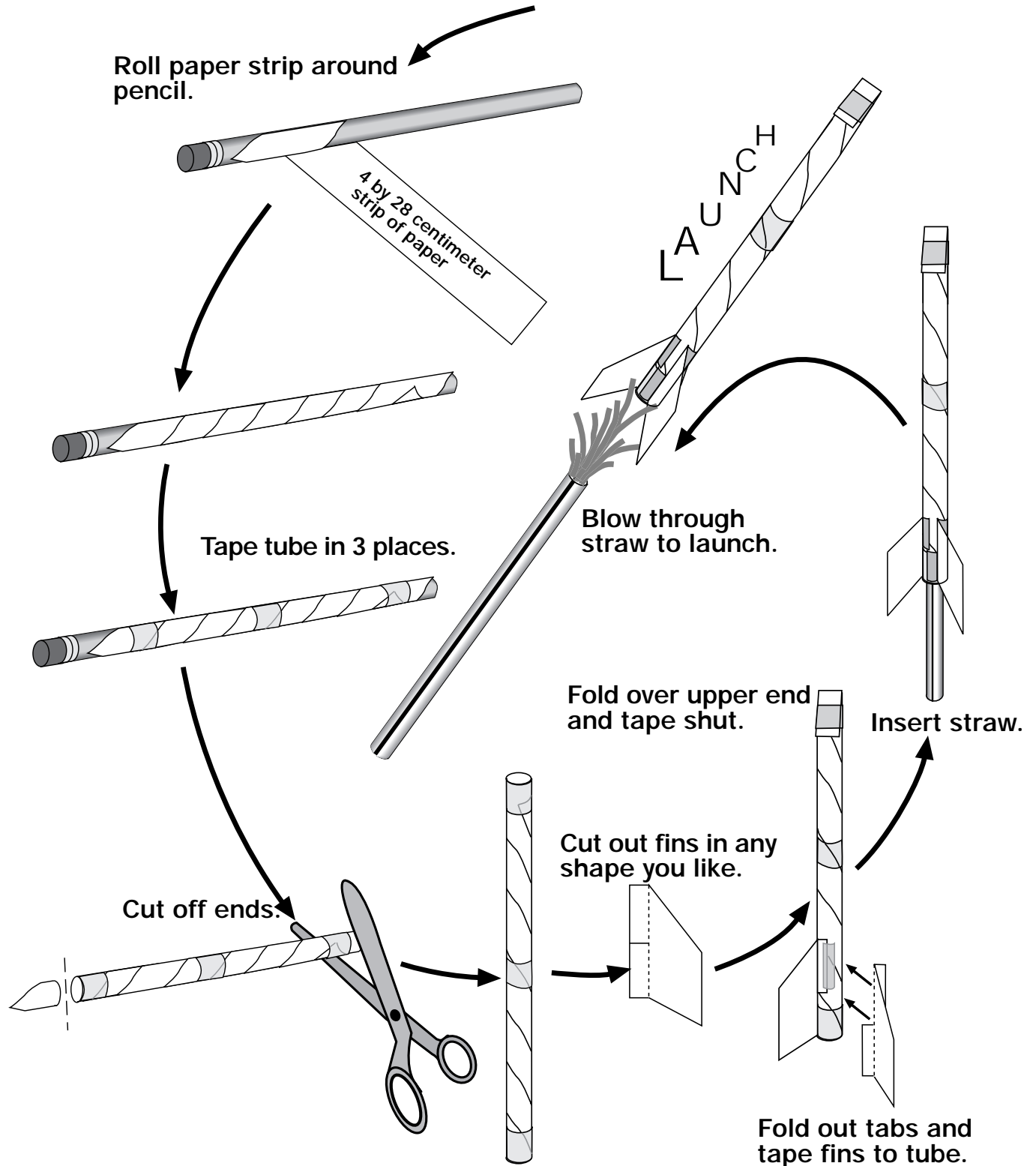

Names: _____

Paper Rocket Test Report

1. Launch your rocket three times. How far did it fly each time. What is the average distance your rocket flew? Write your answer in the spaces below.
2. Build and fly a rocket of a new design. Before flying it, predict how far it will go. Fly the rocket three times and average the distances. What is the difference between your prediction and the actual average distance?
3. Build a third rocket and repeat step 2.
4. On the back of this paper, write a short paragraph describing each rocket you built and how it flew. Draw pictures of the rockets you constructed.

Rocket 1

Make notes about the flights here.

How far did it fly in centimeters?	1. _____ 2. _____ 3. _____	
Average distance in centimeters?	_____	

Rocket 2

Make notes about the flights here.

Predict how many centimeters your rocket will fly.	_____	
How far did it fly in centimeters?	1. _____ 2. _____ 3. _____	
Average distance?	_____	
Difference between your prediction and the average distance?	_____	

Rocket 3

Make notes about the flights here.

Predict how many centimeters your rocket will fly.	_____	
How far did it fly in centimeters?	1. _____ 2. _____ 3. _____	
Average distance?	_____	
Difference between your prediction and the average distance?	_____	

